

49595 - QUADRO ELETTRICO - CONTROL PANEL - CUADRO ELECTRICO - APPAREILLAGE ELECTRIQUE - SCHALTGERAETE

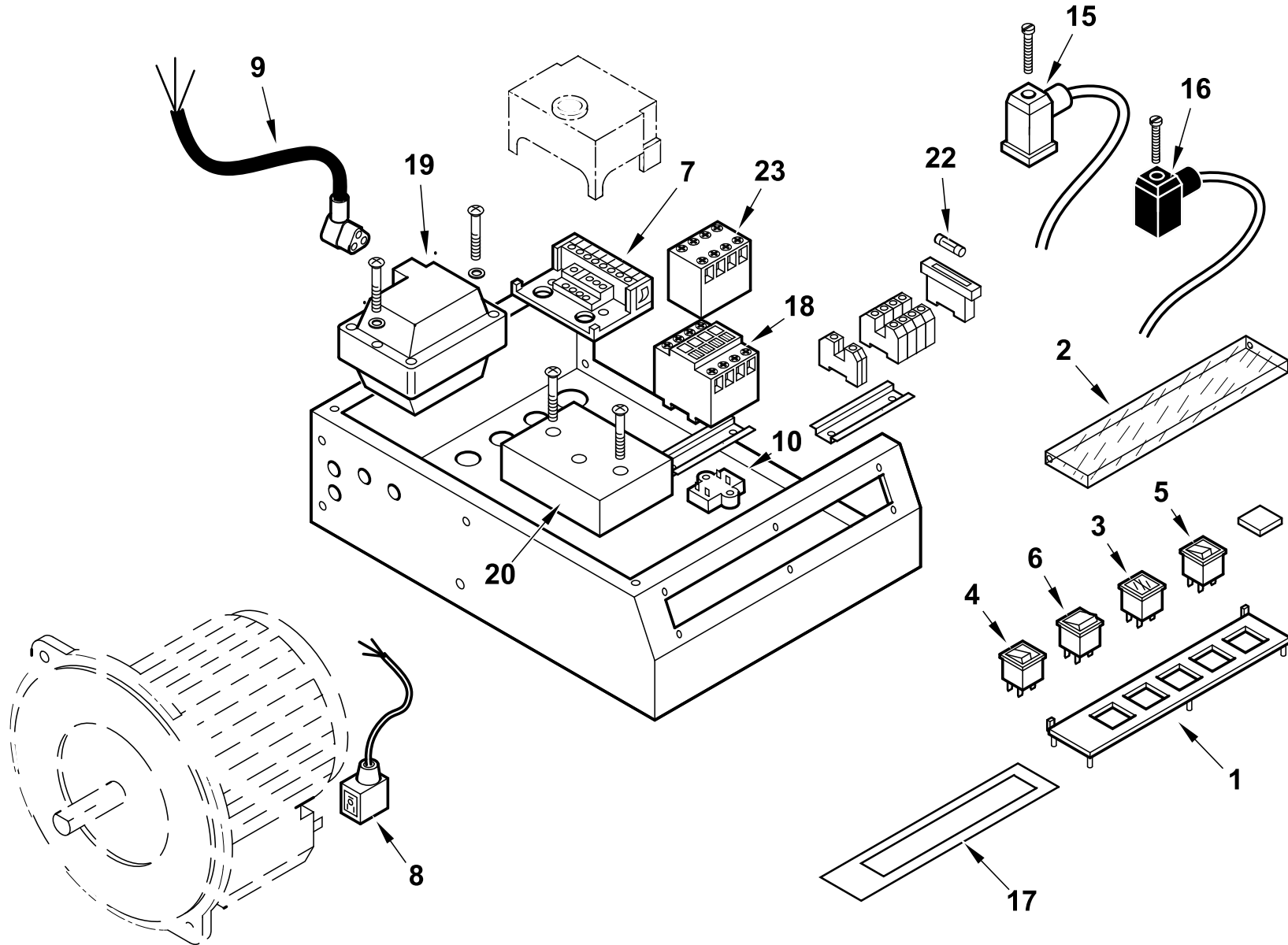

0002991699 rev.2 dis. Balboni
Data: 01-02-2006 visto: Gilli C.

TAV.C204

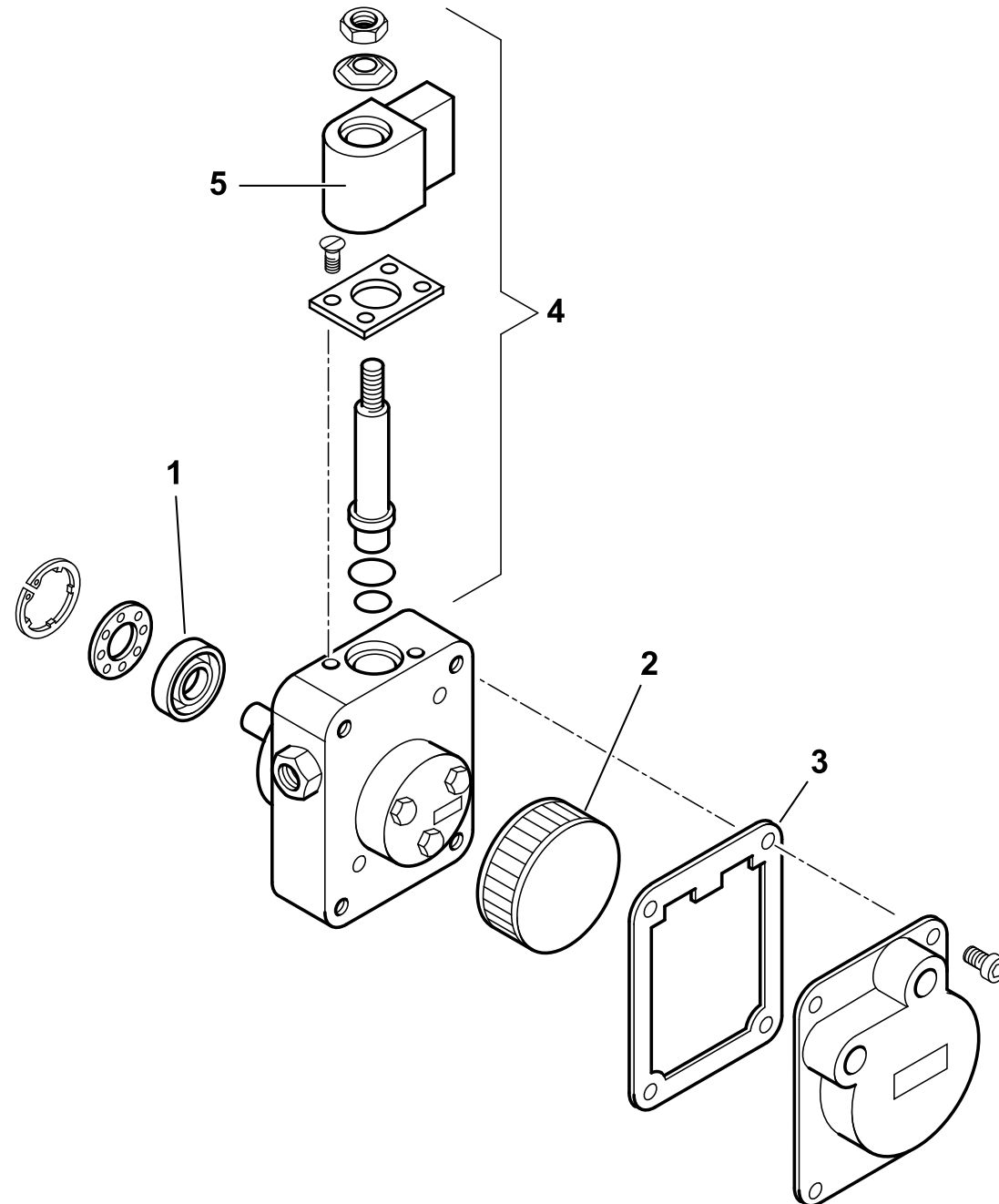

30750 POMPA SUNTEC AS47C 1538 6P0500

| Rif. | Codice | Descrizione |
|------|------------|--------------------------------|
| 1 | 95089 | TENUTA POMPA SUNTEC AN-AS-AE |
| 2 | 0004050030 | FILTRO POMPA SUNTEC A |
| 3 | 0004050049 | GUAR.NE COP. AN-AS-AE-AP-AL-AT |
| 4 | 95115 | ELETTROVALVOLA |
| 5 | 95116 | BOBINA X EV POMPA SUNTEC |

esploso 30750T01 lista L02

| Rif. | Codice | Descrizione |
|------|--------|-------------|
| | | |
| | | |
| | | |
| | | |
| | | |