

R38073 - APPARECCHIATURA - CONTROL PANEL - APPAREILLAGE ELECTRIQUE - SCHALTGERAETE

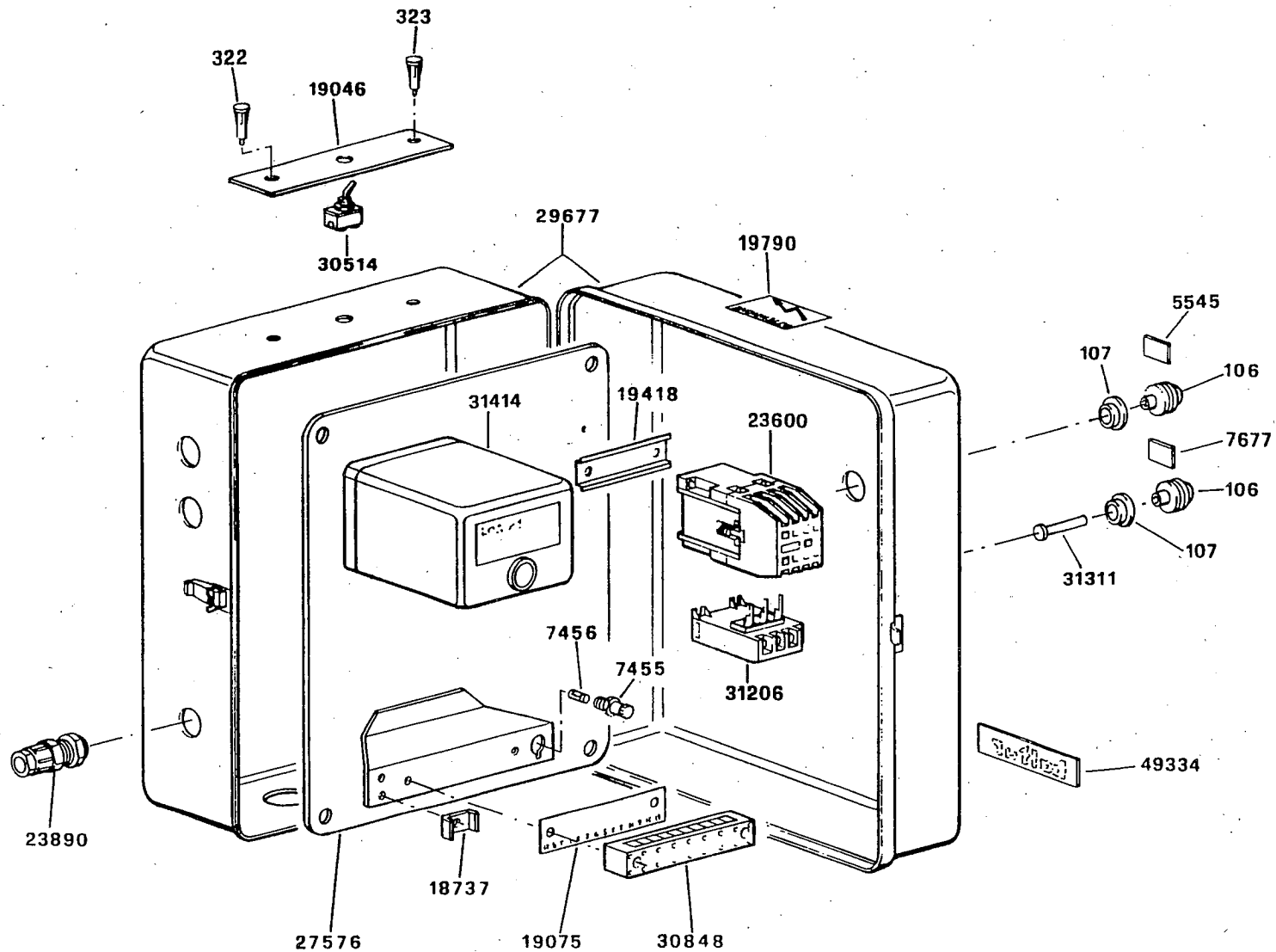

Cod. 0002990912 Rev.0
Data 22-03-94 Dis.Balboni D.