

TAV.C144

901061-QUADRO ELETTRICO - CONTROL PANEL - CUADRO ELECTRICO - APPAREILLAGE ELECTRIQUE - SCHALTGERAETE

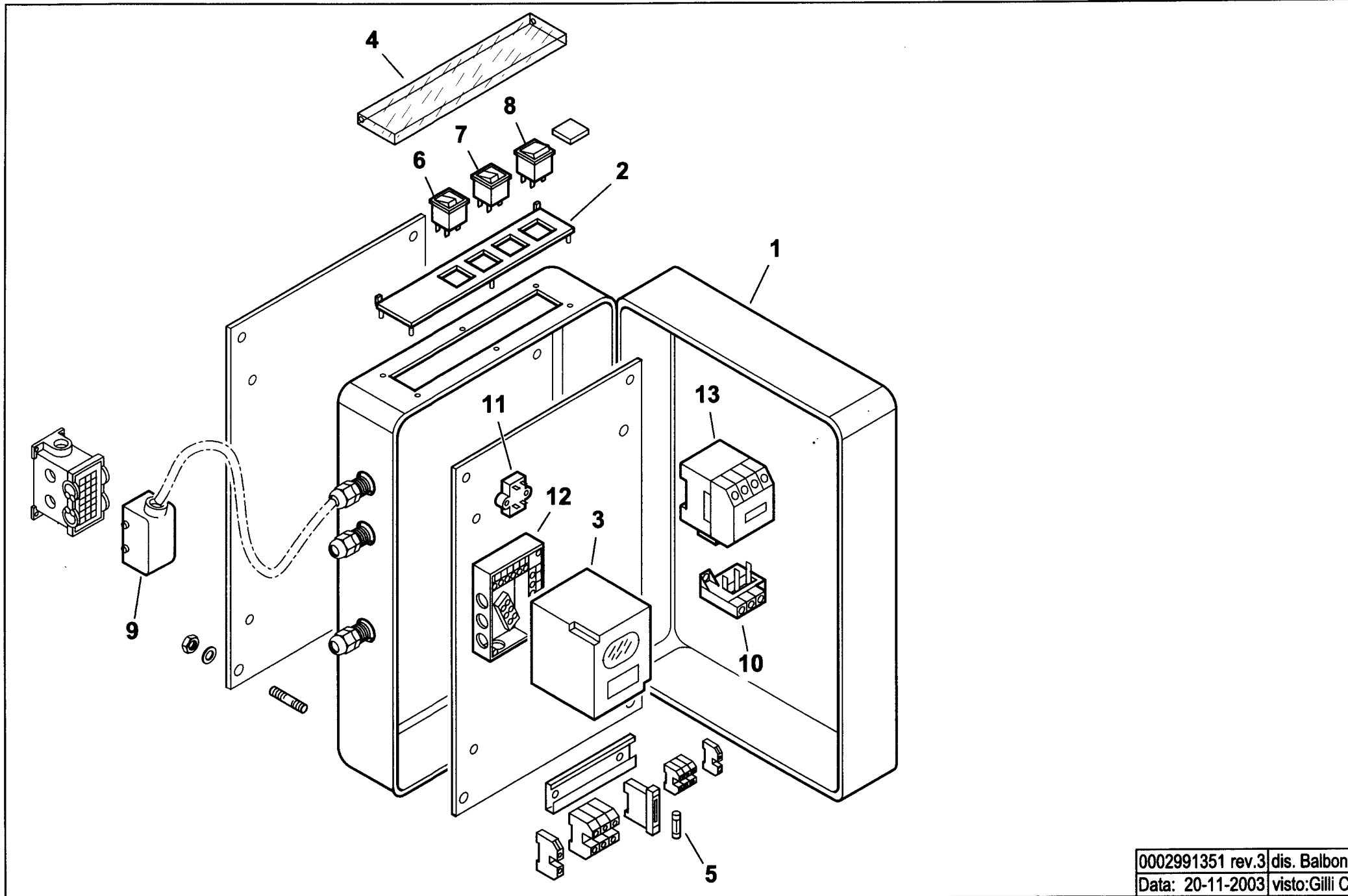

0002991351 rev.3 | dis. Balboni
Data: 20-11-2003 | visto: Gilli C.

TAV.C144

