

TAV.C144

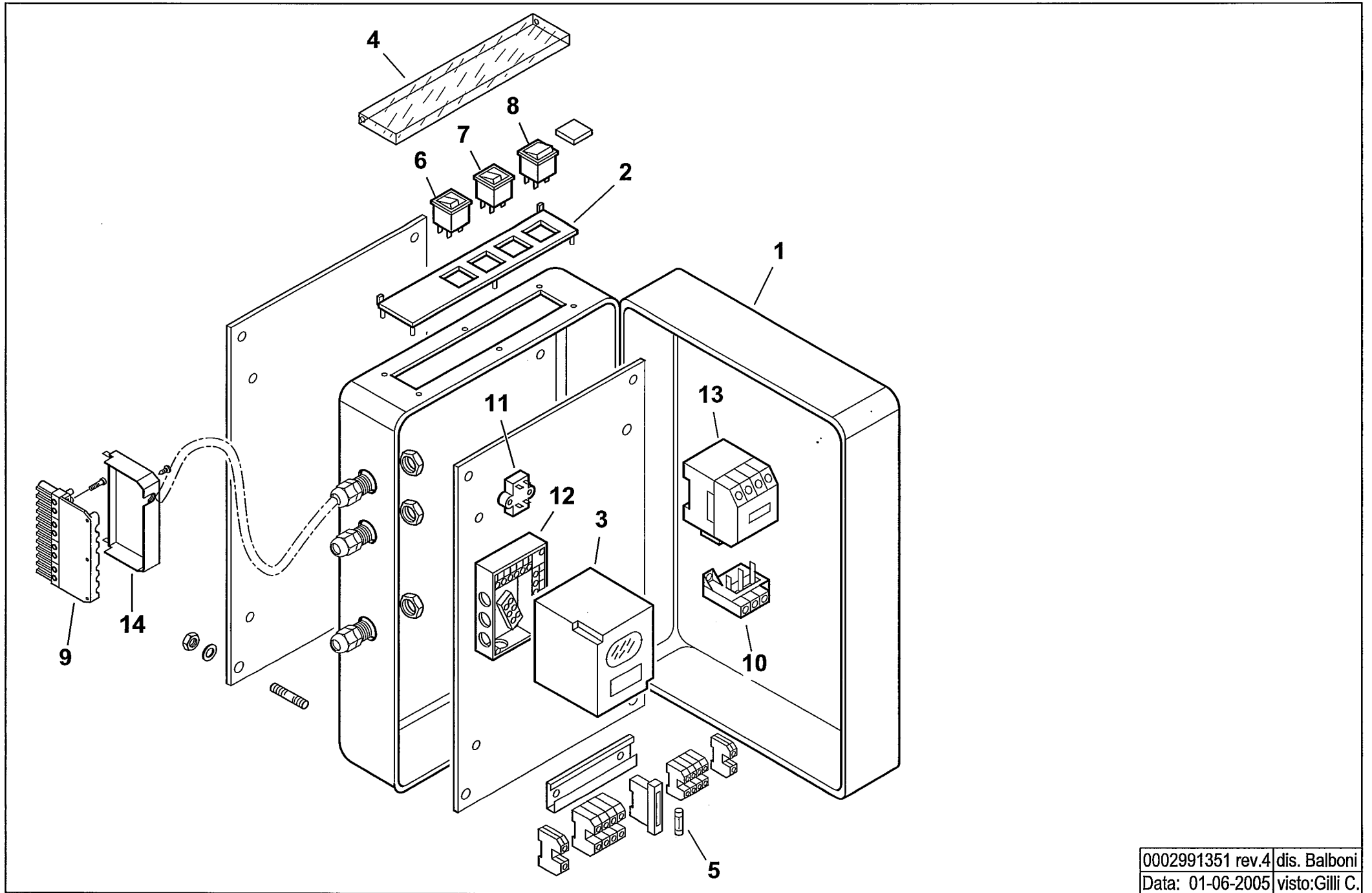

901061-QUADRO ELETTRICO - CONTROL PANEL - CUADRO ELECTRICO - APPAREILLAGE ELECTRIQUE - SCHALTGERAETE



0002991351 rev.4 | dis. Balboni  
Data: 01-06-2005 | visto: Gilli C.

TAV.C144

